

PAPER • OPEN ACCESS

The distribution of stresses and strains in the mating elements disk tools working bodies of roadheaders

To cite this article: A A Khoreshok *et al* 2015 *IOP Conf. Ser.: Mater. Sci. Eng.* **91** 012084

View the [article online](#) for updates and enhancements.

You may also like

- [Ultra-wideband pose detection system for boom-type roadheader based on Caffery transform and Taylor series expansion](#)
Shichen Fu, Yiming Li, Minjun Zhang et al.
- [Dynamic Optimization Design of Transverse Axis Cutting Reducer](#)
Minghu Yin, Hao Liu, Yahui Cui et al.
- [Finite element simulation study on cutting coal and rock by cutting head of roadheader](#)
Jianan Liang, Muqin Tian and Pengfei Huo

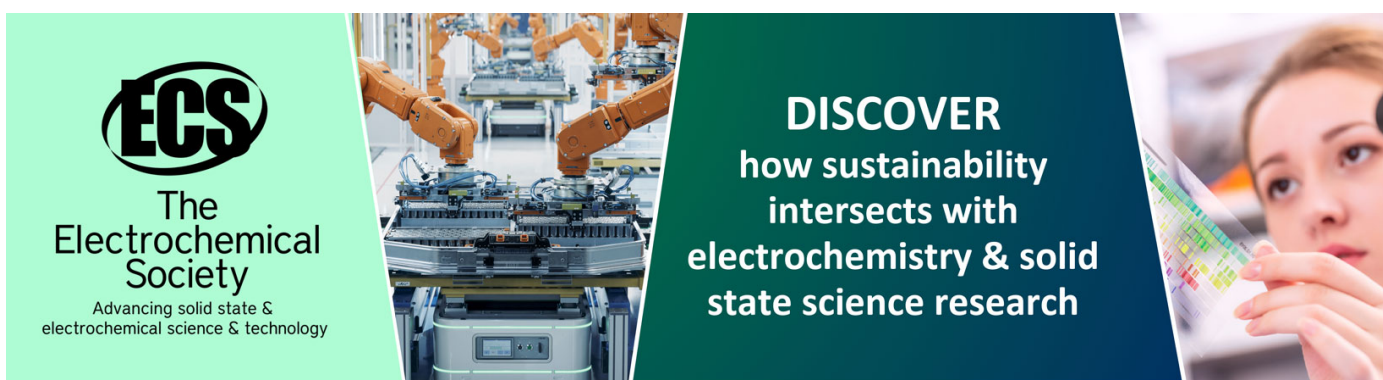

ECS
The
Electrochemical
Society
Advancing solid state &
electrochemical science & technology

DISCOVER
how sustainability
intersects with
electrochemistry & solid
state science research

The distribution of stresses and strains in the mating elements disk tools working bodies of roadheaders

A A Khoreshok^{1,a}, L E Mametyev^{2,b}, A Yu Borisov^{3,c}, A V Vorobyev^{4,d}

^{1,2}Prof. dr.-ing., ³head teacher, ⁴candidate of science (engineering), associate professor

^{1,2,3}Department of Mining Machines and Complexes/Mining Institute,

T.F. Gorbachev KuzSTU, Russia, 650000, Kemerovo, Vesennaya street 28,

^{1,4}Department of Mining Equipment, Yurga Institute of Technology, TPU affiliate

Russia, 652055, Yurga, Leningradskaya street 26

E-mail: ^a haa.omit@kuzstu.ru, ^{b,c} bau.asp@rambler.ru, ^d vorob@tpu.ru

Abstract. Presents the results of modeling the stress-strain state in the mating structural elements of the attachment disk tools various design on triangular and tetrahedral prisms working bodies of roadheaders selective action in the destruction of coalface of heterogeneous structure.

1. Introduction

In the world practice of conducting underground mining is a widespread tool, disc and roller tools to equip working bodies roadheaders, shield tunneling complexes and aggregates [1–13]. The Department Mining machines and complexes, T.F. Gorbachev KuzSTU together with the Department of Mining Equipment of YUTI (affiliate) TPU conducted research aimed at developing constructive modules of the attachment disk of the instrument, is in charge of maintaining the extension of the scope of working bodies of roadheaders selective action on the destruction of structurally heterogeneous coal and rock face. Evaluation of the effectiveness of the developed technical solutions is carried out by results of modeling the stress-strain state of the use of the finite element method.

2. The distribution of equivalent stresses in conjugate constructive elements of the attachment of the disk tool to a polygonal prisms

When modeling the stress state of structures of triangular prisms with the attachment of the three options (Figure 1, a, b, c) and tetrahedral prisms (Figure 1, d, e) used four design disk tool diameter $D = 160$ mm (three biconical with angles of taper: 1 – $\varphi = \varphi_1 + \varphi_2 = 5^\circ + 25^\circ = 30^\circ$; 2 – $10^\circ + 20^\circ = 30^\circ$; 3 – $15^\circ + 15^\circ = 30^\circ$ and one tapered 4 – $\varphi = 0^\circ + 30^\circ$). It should be noted that the angle of taper φ_1 biconical disc facing tool to the surface of the exposed face of the tunnel excavation.

In table 1 and Figure 2 presents the dependence of the equivalent stress distribution σ_{ekv} from conjugate diameters D of the structural elements of the attachment of the disk tool to the triangular prisms for the predicted coalface fracture of rocks with $\sigma_{comp} = 70$ MPa. At the same characteristic cross sections pass through the edge of the disc and following cross mating elements: - for the first variant in Figure 1, a (1 – disc, 2 – axle-pivot), for the second and third variants in Figure 1, b (1 – disc, 2 – pivot, 3 – axle with thrust collar).



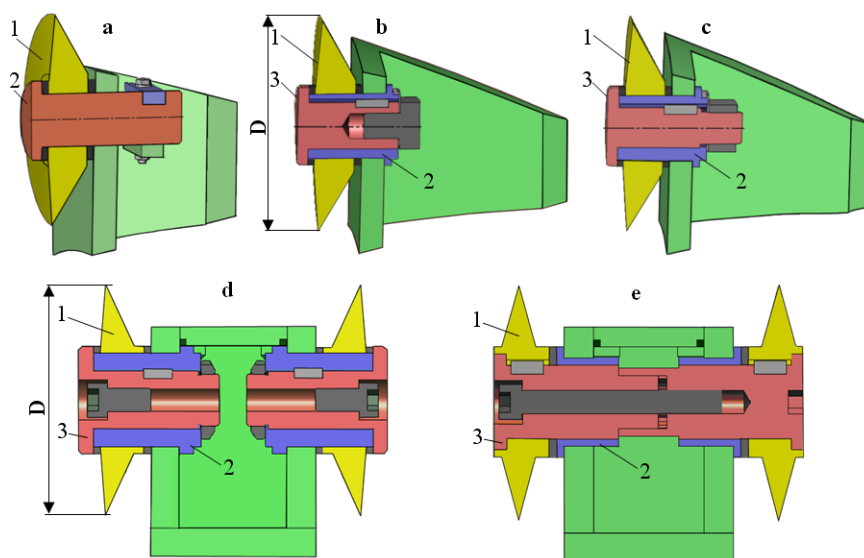

Figure 1. The design of the mating elements of the attachment of the disk tool on the polygonal prisms: a – with strap-lock, b – with screw; c – with nut; d – separated nodes mount disks; e – tandem nodes mount disks

Table 1. The distribution of equivalent stresses in the destruction of the face disk tool on the triangular prism crowns roadheaders

Options nodes attachment	The angles of taperdiscs $\varphi = \varphi_1 + \varphi_2, ^\circ$	Polynomial according	Validity coefficients of approximation R^2
I	1	$\sigma_{ekv} = -4E-10D^6 + 2E-07D^5 - 4E-05D^4 + 0.0036D^3 - 0.13D^2 + 2.1824D - 3.364$	0.9116
	2	$\sigma_{ekv} = -2E-10D^6 + 1E-07D^5 - 3E-05D^4 + 0.0028D^3 - 0.1138D^2 + 1.8771D - 2.6505$	0.9
	3	$\sigma_{ekv} = -4E-10D^6 + 2E-07D^5 - 5E-05D^4 + 0.0044D^3 - 0.1686D^2 + 2.5206D - 4.4542$	0.875
	4	$\sigma_{ekv} = 2E-10D^6 - 1E-07D^5 + 2E-05D^4 - 0.0011D^3 + 0.0297D^2 + 0.0692D + 0.8159$	0.8987
II	1	$\sigma_{экс} = -1E-10D^6 + 8E-08D^5 - 2E-05D^4 + 0.002D^3 - 0.0932D^2 + 1.8159D - 3.217$	0.9143
	2	$\sigma_{ekv} = 2E-10D^6 - 2E-08D^5 - 4E-06D^4 + 0.0011D^3 - 0.0686D^2 + 1.5676D - 2.8298$	0.8901
	3	$\sigma_{ekv} = 5E-10D^6 - 2E-07D^5 + 2E-05D^4 - 0.0008D^3 - 0.0002D^2 + 0.6508D - 1.3489$	0.8752
	4	$\sigma_{ekv} = 6E-10D^6 - 3E-07D^5 + 4E-05D^4 - 0.0031D^3 + 0.0984D^2 - 0.7694D + 2.4977$	0.9467
III	1	$\sigma_{ekv} = -1E-10D^6 + 6E-08D^5 - 1E-05D^4 + 0.0014D^3 - 0.0648D^2 + 1.5159D - 3.3668$	0.9004
	2	$\sigma_{ekv} = -3E-11D^6 + 6E-08D^5 - 2E-05D^4 + 0.0022D^3 - 0.1041D^2 + 2.0006D - 4.0917$	0.9003
	3	$\sigma_{ekv} = 4E-10D^6 - 1E-07D^5 + 1E-05D^4 - 4E-05D^3 - 0.0253D^2 + 0.921D - 1.7204$	0.9011
	4	$\sigma_{ekv} = -3E-10D^6 + 1E-07D^5 - 2E-05D^4 + 0.0012D^3 - 0.0291D^2 + 0.4971D + 0.2927$	0.8799

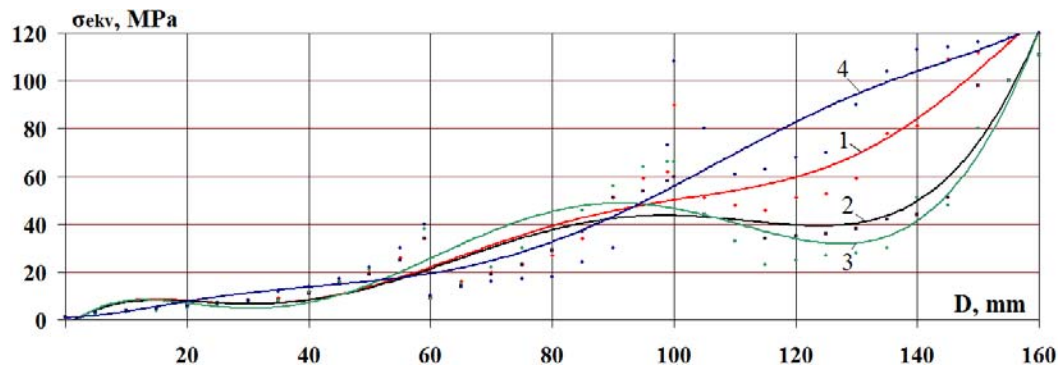

Figure 2. Dependence of the distribution of equivalent stresses σ_{ekv} of the diameter D of the mating structural elements in the cross section passing through the flange of the disk tool to a first variant of the attachment point to the triangular prism (Figure 1, a): 1, 2, 3, 4 – the angles of taper disks $\varphi = \varphi_1 + \varphi_2$ (table 1)

In table 2 and Figure 3, 4 shows the picture and dependence on the distribution of equivalent stresses σ_{ekv} from conjugate diameters D of the structural elements of the attachment with separate disk tools to a tetrahedral prism (Figure 1, d) for the predicted destruction of the face: coal (1 – $\sigma_{comp} = 12.4$ MPa), breed (2 – $\sigma_{comp} = 51$ MPa; 3 – $\sigma_{comp} = 60.6$ MPa; 4 – $\sigma_{comp} = 78.9$ MPa). Thus, the mating structural elements in the characteristic cross-section are (fig. 1, d): 1 – disc, 2 – pivot, 3 – axle with thrust collar.

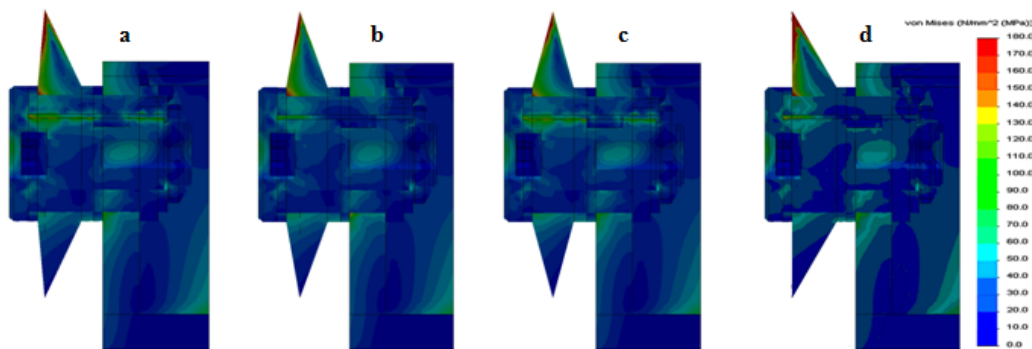

Figure 3. The distribution of equivalent stresses σ_{ekv} on the von Mises criterion in the attachment to the tetrahedral prism with the destruction of the rock mass $\sigma_{comp} = 60.6$ MPa separate disk tools with angles of taper: a – $\varphi = 5^\circ + 25^\circ$, b – $\varphi = 10^\circ + 20^\circ$; c – $\varphi = 15^\circ + 15^\circ$; d – $\varphi = 0^\circ + 30^\circ$

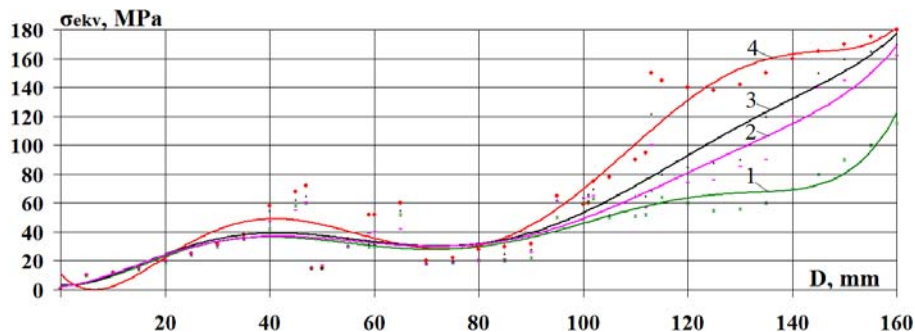

Figure 4. Dependence of the distribution of equivalent stresses σ_{ekv} of the diameter D of the mating structural elements in the cross section passing through the flange disk tool $\varphi = 5^\circ + 25^\circ$ attachment point to tetrahedral prism (table 2): 1 – $\sigma_{comp} = 12.4$ MPa; 2 – $\sigma_{comp} = 51$ MPa; 3 – $\sigma_{comp} = 60.6$ MPa; 4 – $\sigma_{comp} = 78.9$ MPa

Table 2. The distribution of equivalent stresses in the destruction of face the separate disc tool on the tetrahedral prisms roadheaders

Comers sharpening two discs $\varphi = \varphi_1 + \varphi_2, ^\circ$	Face $\sigma_{comp}, \text{MPa}$		Polynomial according	Validity coefficients of approximation R^2
	1	2		
5°+25°	1	12.4	$\sigma_{ekv} = 9E-10D^6 - 4E-07D^5 + 7E-05D^4 - 0.005D^3 + 0.1473D^2 - 0.4312D + 3.5697$	0.8307
	2	51	$\sigma_{ekv} = 5E-10D^6 - 3E-07D^5 + 5E-05D^4 - 0.0034D^3 + 0.0955D^2 + 0.236D + 2.227$	0.9124
	3	60.6	$\sigma_{ekv} = 6E-10D^6 - 3E-07D^5 + 5E-05D^4 - 0.0041D^3 + 0.1219D^2 - 0.0698D + 2.6707$	0.9093
	4	78.9	$\sigma_{ekv} = 2E-09D^6 - 8E-07D^5 + 0.0001D^4 - 0.0115D^3 + 0.3972D^2 - 3.802D + 11.028$	0.9305
10°+20°	1	12.4	$\sigma_{ekv} = 9E-10D^6 - 4E-07D^5 + 7E-05D^4 - 0.0051D^3 + 0.1618D^2 - 0.792D + 4.5062$	0.8155
	2	51	$\sigma_{ekv} = 4E-10D^6 - 1E-07D^5 + 2E-05D^4 - 0.0011D^3 - 0.0011D^2 + 1.5566D - 0.5273$	0.8962
	3	60.6	$\sigma_{ekv} = 7E-10D^6 - 3E-07D^5 + 5E-05D^4 - 0.0033D^3 + 0.0822D^2 + 0.4756D + 1.7038$	0.8832
	4	78.9	$\sigma_{ekv} = 5E-10D^6 - 2E-07D^5 + 4E-05D^4 - 0.003D^3 + 0.0857D^2 + 0.3425D + 1.9343$	0.8462
15°+15°	1	12.4	$\sigma_{ekv} = 1E-09D^6 - 5E-07D^5 + 9E-05D^4 - 0.0071D^3 + 0.2323D^2 - 1.9484D + 4.5644$	0.704
	2	51	$\sigma_{ekv} = 7E-10D^6 - 3E-07D^5 + 4E-05D^4 - 0.0025D^3 + 0.045D^2 + 0.8656D - 0.1547$	0.8645
	3	60.6	$\sigma_{ekv} = 6E-10D^6 - 2E-07D^5 + 3E-05D^4 - 0.0017D^3 + 0.0208D^2 + 1.1856D - 0.8734$	0.8712
	4	78.9	$\sigma_{ekv} = 8E-10D^6 - 3E-07D^5 + 5E-05D^4 - 0.0031D^3 + 0.0604D^2 + 0.9739D - 0.1622$	0.763
0°+30°	1	12.4	$\sigma_{ekv} = 8E-10D^6 - 4E-07D^5 + 8E-05D^4 - 0.0059D^3 + 0.1813D^2 - 0.9435D + 1.7707$	0.8275
	2	51	$\sigma_{ekv} = 1E-09D^6 - 7E-07D^5 + 0.0001D^4 - 0.0099D^3 + 0.3281D^2 - 2.8843D + 6.5965$	0.8627
	3	60.6	$\sigma_{ekv} = 2E-09D^6 - 8E-07D^5 + 0.0001D^4 - 0.0108D^3 + 0.3579D^2 - 3.1909D + 6.9559$	0.8572
	4	78.9	$\sigma_{ekv} = 2E-09D^6 - 9E-07D^5 + 0.0002D^4 - 0.0125D^3 + 0.4166D^2 - 3.8895D + 7.5362$	0.8501

In Figure 5 and table 3 presents the dependence of the distribution of equivalent stress σ_{ekv} on the von Mises criterion in the mating structural components of the mount disk tool on tetrahedral prism with the destruction of the mountain massif σ_{comp} . Features of the mountain massif: coal ($\sigma_{comp} = 12.4 \text{ MPa}; 13.5 \text{ MPa}; 14.8 \text{ MPa}$) and breed ($\sigma_{comp} = 51 \text{ MPa}; 60.6 \text{ MPa}; 78.9 \text{ MPa}$). The analysis of dependencies in the cross section passing through the cutting edge of each of the four disks of diameter $D = 160 \text{ mm}$ according to the angles of taper: (biconical: $\varphi = \varphi_1 + \varphi_2 = 5^\circ + 25^\circ = 30^\circ$; $10^\circ + 20^\circ = 30^\circ$; $15^\circ + 15^\circ = 30^\circ$ and cone $\varphi = 0^\circ + 30^\circ$).

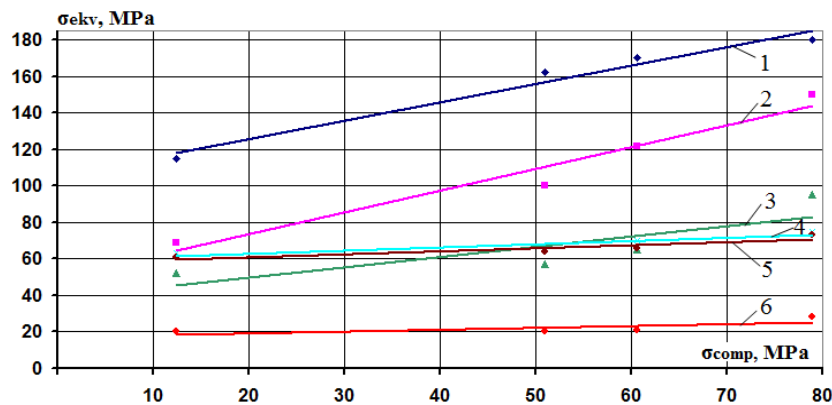

Figure 5. Dependence equivalent stress σ_{ekv} from the tensile strength of the destroyed mountain massif on compression σ_{comp} in diametrical section along the wedge flange of the disk ($\varphi = 5^\circ + 25^\circ = 30^\circ$) for mating structural elements 1–6 (table 3) of the attachment point to tetrahedral prism (Figure 1, d)

Table 3. The distribution of equivalent stresses σ_{ekv} in conjugate constructive elements of the attachment disk tools to the tetrahedral prisms

Corners sharpening two discs $\varphi = \varphi_1 + \varphi_2, ^\circ$	The surface simulation of mating structural elements	Dependence	Validity coefficients of approximation R^2
$5^\circ + 25^\circ$	1 along the edge of the disk	$\sigma_{ekv} = 1.0115 \sigma_{comp} + 105.44$	0.9711
	2 at the hub of the disc	$\sigma_{ekv} = 1.1923 \sigma_{comp} + 49.771$	0.9519
	3 on the outer surface of the pivot	$\sigma_{ekv} = 0.5683 \sigma_{comp} + 38.424$	0.685
	4 on the inner surface of the pivot	$\sigma_{ekv} = 0.1728 \sigma_{comp} + 59.486$	0.8121
	5 on the outer surface of the axis	$\sigma_{ekv} = 0.1645 \sigma_{comp} + 57.655$	0.819
	6 in the center of the axis	$\sigma_{ekv} = 0.0997 \sigma_{comp} + 17.194$	0.5241
$10^\circ + 20^\circ$	1 along the edge of the disk	$\sigma_{ekv} = 1.153 \sigma_{comp} + 94.515$	0.963
	2 at the hub of the disc	$\sigma_{ekv} = 0.7837 \sigma_{comp} + 59.495$	0.9911
	3 on the outer surface of the pivot	$\sigma_{ekv} = 0.4563 \sigma_{comp} + 23.353$	0.9969
	4 on the inner surface of the pivot	$\sigma_{ekv} = 0.273 \sigma_{comp} + 49.9$	0.851
	5 on the outer surface of the axis	$\sigma_{ekv} = 0.921 \sigma_{comp} + 35.783$	0.5218
	6 in the center of the axis	$\sigma_{ekv} = 0.2206 \sigma_{comp} + 22.06$	0.7235
$15^\circ + 15^\circ$	1 along the edge of the disk	$\sigma_{ekv} = 0.9396 \sigma_{comp} + 103.59$	0.9442
	2 at the hub of the disc	$\sigma_{ekv} = 0.5622 \sigma_{comp} + 53.984$	0.5191
	3 on the outer surface of the pivot	$\sigma_{ekv} = 0.3284 \sigma_{comp} + 16.344$	0.9024
	4 on the inner surface of the pivot	$\sigma_{ekv} = 0.1354 \sigma_{comp} + 56.883$	0.4664
	5 on the outer surface of the axis	$\sigma_{ekv} = 0.5446 \sigma_{comp} + 47.124$	0.4087
	6 in the center of the axis	$\sigma_{ekv} = 0.3868 \sigma_{comp} + 9.6287$	0.9629
$0^\circ + 30^\circ$	1 along the edge of the disk	$\sigma_{ekv} = 0.9328 \sigma_{comp} + 116.43$	0.8789
	2 at the hub of the disc	$\sigma_{ekv} = 0.4487 \sigma_{comp} + 115.99$	0.9884
	3 on the outer surface of the pivot	$\sigma_{ekv} = 0.4338 \sigma_{comp} + 38.498$	0.8523
	4 on the inner surface of the pivot	$\sigma_{ekv} = 1.2391 \sigma_{comp} + 38.897$	0.9435
	5 on the outer surface of the axis	$\sigma_{ekv} = 0.4039 \sigma_{comp} + 98.013$	0.6492
	6 in the center of the axis	$\sigma_{ekv} = 0.0282 \sigma_{comp} + 9.5708$	0.9368

3. Displacement in conjugate constructive elements of the attachment of the disk tool to a polygonal prisms

For mating structural elements of the attachment of each of the four disk tools to triangular prisms (Figure 1, a, b, c) and the tetrahedral prisms (Figure 1, d) a simulation of displacement (Figure 6, 7). Results of modeling displacements allow us to estimate the stiffness of the mating structural elements of the attachment disk tool of the instrument including clearances, fits and tolerances, linear and diametrical dimensions in the destruction of face tunneling mining. When modeling the displacement eliminates jamming in the work of the structural elements of the mount, which may occur due to elastic deformations of the structure under load.

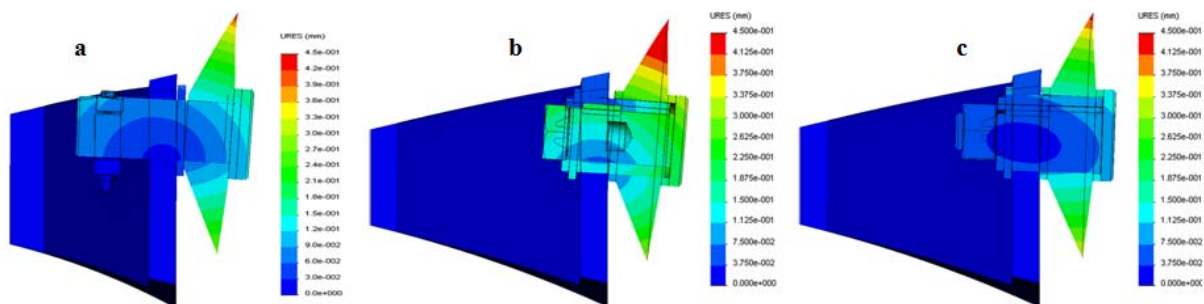

Figure 6. Displacement of structural elements in the attachment biconical disk tool ($\varphi = 5^\circ + 25^\circ = 30^\circ$) to the triangular prisms in the destruction of the rock face $\sigma_{\text{comp}} = 70$ MPa: a – with strap-lock, b – with screw; c – with nut

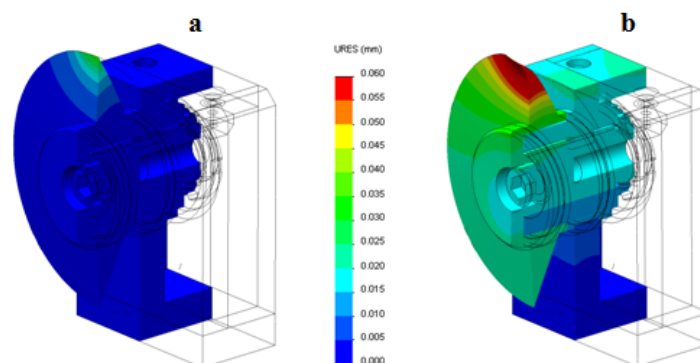

Figure 7. Displacement separate structural elements of the attachment biconical disk tool ($\varphi = 5^\circ + 25^\circ = 30^\circ$) to the tetrahedral prisms in the destruction of faces: a – coal $\sigma_{\text{comp}} = 12.4$ MPa; b – rock $\sigma_{\text{comp}} = 60.6$ MPa

It should be noted that the modeling of the displacements of two separate disk tools with attachment points on tetrahedral prisms in Figure 7 presents through half the image of paintings of the distribution of displacements in the destruction of coal massif (Figure 7, a) and rock massif (Figure 7, b).

Conclusion

The analysis results presented above on the distribution of equivalent stresses σ_{ekv} from conjugate diameters D of the structural elements of the attachment of the disk tool to triangular and tetrahedral prism showed the presence of zones with maximum values in peripheral downhole portion of discs with different angles of taper and the pair of hub discs with the surfaces of pins or axles on which the disc can rotate freely.

The minimum level of equivalent stress σ_{ekv} and displacements in the destruction of faces ($\sigma_{\text{comp}} = 12.4\text{--}78.9$ MPa) is marked by the installation of a biconical disk tool ($\varphi = 5^\circ + 25^\circ = 30^\circ$; $10^\circ + 20^\circ =$

30°; 15°+15° = 30°), a maximum value of equivalent stress σ_{ekv} and displacement was observed when using conical disk tool ($\varphi = 0^\circ+30^\circ$).

In designs biconical disk tool when you change the angles of taper from asymmetric ($\varphi = 5^\circ+25^\circ$; $10^\circ+20^\circ$) to symmetric ($\varphi = 15^\circ+15^\circ$) recorded a reduction in the estimated level of maximum equivalent stress σ_{ekv} and displacements from a symmetric disk for all cases of loading.

Dependence of the distribution of equivalent stresses σ_{ekv} according to the von Mises criterion on the diameter D of the mating structural elements in the cross section passing through the flange of the disk tool on the polygonal prism describes a polynomial dependency of the sixth order. This dependence of the distribution of equivalent stresses σ_{ekv} according to the von Mises criterion on the edges of the disk tools of the console attachment to the tetrahedral prism indicators are destroying the mountain massif σ_{comp} are described by linear dependence.

Marked decrease in the size of zones of maximum equivalent stress σ_{ekv} and displacements on downhole face of the triangular prism (Figure 1, c) drawn to the face in the third variant of the mount disk tool, compared with the second variant (Figure 1, b), which characterizes the increase in the rigidity of fastening of the nut compared to the screw.

The results of these studies allowed the development of a coupled node of the fastening clip of the double disc tool on the tetrahedral prism according to the patent of the Russian Federation 146845 (Figure 1, e). Here, the mating structural elements in the typical section are: disc, pivot, axle with thrust collar. Distinctive features of this technical solution is that the joint condition of free rotation of the two disks represents the coaxial pins-bushings is achieved by the presence of a single prefabricated structural unit, which is made in the form of rigidly attached to each other two axes with thrust ribs, one of which contains a slotted shank, and the other contains a slotted bushing. Such design implies a reduction process jamming and wear double disc tools, rational redistribution of equivalent stress σ_{ekv} with the notch of the working body of roadheaders with axial crowns.

Recommended combined scheme of the set disk tool on the casing of the distributing gear between axial crowns of the working body of roadheaders with the placement of conical discs in the central zone, and biconical disk in other zones across the width between the crowns.

Further research aimed at modelling and evaluation of stress-strain state of the mating structural elements of the attachment of the coupled disk tools on tetrahedral prisms (patent of the Russian Federation 146845).

Technical solutions and test results were obtained within the base part of Ministry of Education and Science of Russia state order, project 632 "Investigation of technologies and techniques parameters for selecting and developing innovative designs to improve operating efficiency of multipurpose mining machines in Kuzbass".

Acknowledgements

The authors wish to express their gratitude and appreciation to the first deputy chief mechanic on the mountain-mine equipment in company "SUEK-Kuzbass" Mukhortikov S.G, head of the laboratory of coal geotechnology Institute of Coal, Siberian branch of the Russian Academy of Sciences, doctor Ingeniariae Aksenov V.V., head of Department of Machine tools and cutting tools, professor, doctor Ingeniariae Korotkov A. N., professor of the Department of Mechanical engineering, doctor Ingeniariae Blumenstein V.Yu, head of the Center of Informatization, candidate of science (engineering), associate professor of Department of Mining equipment, Yurga Institute of Technology, TPU affiliate Vorobyov A.V. for active creative cooperation and support.

References

- [1] Aksenov V V, Efremkov A B, Beglyakov V Yu 2013 The influence of relative distance between ledges on the stress-strain state of the rock at a face *Applied mechanics and materials*. vol. 379, pp. 16-19.

- [2] Aksenov V V, Khoreshok A A, Beglyakov V Yu 2013 Justification of creation of an external propulsor for multipurpose shield-type heading machine – Geo-walker *Applied mechanics and materials*. vol. 379, pp. 20-23.
- [3] Hong K R, Yang R H 2011 The major problems and countermeasures on the shield machine tunneling in the hard rock stratum *Applied mechanics and materials*. vols. 105-107, pp. 1438-1442.
- [4] Prokopenko S A 2014 Multiple service life extension of mining and road machines' cutters *Applied mechanics and materials*. vol. 682, pp. 319-323.
- [5] Li X H, Du W, Huang Z L, Fu W L 2011 Simulation of disc cutter loads based on ANSYS/LS-DYNA *Applied mechanics and materials*. vol. 127, pp. 385-389.
- [6] Zhao B, Zong X M, He B, Zhang L J 2014 Multi variable multi objective optimization for the cutting head of roadheader *Applied mechanics and materials*. vols. 635-637, pp. 358-364.
- [7] Zhang Y, Wang X W, Liu H F 2014 Numerical simulation of rock-breaking process by disc cutter in tunnel boring machine *Applied mechanics and materials*. vol. 487, pp. 513-516.
- [8] Li F H, Cai Z X, Kang Y L 2011 A theoretical model for estimating the wear of the disc cutter *Applied mechanics and materials*. vols. 90-93, pp. 2232-2236.
- [9] Zhou Z L, Li X B, Zhao G Y, Liu Z X, Xu G J 2011 Excavation of high-stressed hard rock with roadheader *Applied mechanics and materials*. vols. 52-54, pp. 905-908.
- [10] Wang X D, Shi M Q, Gao S J, Guo Y C 2014 Design of transverse boom-type roadheader remote control system *Applied mechanics and materials*. vols. 701-702, pp. 679-683.
- [11] Khoreshok A A, Mametev L E, Borisov A Yu, Vorobev A V 2015 Finite element models of disk tools with attachment points on triangular prisms *Applied mechanics and materials*. vol. 770. pp. 429-433.
- [12] Khoreshok A A, Mametev L E, Borisov A Yu, Vorobev A V 2015 Stress state of disk tool attachment points on tetrahedral prisms between axial bits *Applied mechanics and materials*. vol. 770. pp. 434-438.
- [13] Khoreshok A, Mametyev L, Bosirov A, Vorobiev A (2014, October) Stress-deformed state knots fastening of a disk tool on the crowns of roadheaders. *Taishan Academic Forum – Project on mine disaster prevention and control*. Atlantis Press, Amsterdam – Paris - Beijing, pp. 177-183.



IOPscience



Journals ▼

Books

Publishing Support



Login ▼

Table of contents

Volume 91

2015

← Previous issue Next issue →

VI International Scientific Practical Conference on Innovative Technologies and Economics in Engineering 21–23 May 2015, Yurga, Russia

Accepted papers received: 28 July 2015

Published online: 14 September 2015

Open all abstracts

Preface

OPEN ACCESS 011001

VI International Scientific Practical Conference on Innovative Technologies and Economics in Engineering

Dmitry A Chinakhov

 [View article](#)  [PDF](#)

OPEN ACCESS 011002

Peer review statement

 [View article](#)  [PDF](#)

Papers

Topic 1: Innovative technologies for producing and testing permanent joints in mechanical engineering

OPEN ACCESS 012001

Nickel and titanium nanoboride composite coating

K A Efimova, G V Galevsky, V V Rudneva, N A Kozyrev and E G Orshanskaya

 [View article](#)  [PDF](#)

OPEN ACCESS 012002

Synthesis and properties of nanoscale titanium boride

K A Efimova, G V Galevskiy and V V Rudneva

 [View article](#)  [PDF](#)

 [View article](#)  [PDF](#)

OPEN ACCESS

012003

Silicon nano-carbide in strengthening and ceramic technologies

V V Rudneva, G V Galevsky and N A Kozyrev

 [View article](#)  [PDF](#)

OPEN ACCESS

012004

Peculiarities of Production of Chromium Carbonitride Nanopowder and Its Physical-Chemical Certification

L S Shiryayeva, I V Nozdrin and G V Galevsky

 [View article](#)  [PDF](#)

OPEN ACCESS

012005

Conceptual model of resource assessment of fuel and energy complex long working equipment on the basis of structural criteria

A N Smirnov and N V Ababkov

 [View article](#)  [PDF](#)

OPEN ACCESS

012006

Physical Nature of the Processes in Forming Structures, Phase and Chemical Compositions of Medium-Carbon Steel Welds

D P Il'yaschenko, D A Chinakhov, V I Danilov, G V Schlyakhova and Yu M Gotovshchik

 [View article](#)  [PDF](#)

OPEN ACCESS

012007

Increasing Strength and Operational Reliability of Fixed Joints of Tubes by MMA Welding

D P Il'yaschenko, D A Chinakhov, V I Danilov, G V Schlyakhova and Y M Gotovschik

 [View article](#)  [PDF](#)

OPEN ACCESS

012008

New Tendencies in Development of Carbonaceous Additives for Welding Fluxes

N A Kozyrev, R E Kryukov and O A Kozyreva

 [View article](#)  [PDF](#)

OPEN ACCESS

012009

Surfacing With Tungsten-containing Ores

N A Kozyrev, G V Galevsky, D V Valuev, V M Shurupov and O E Kozyreva

 [View article](#)  [PDF](#)

OPEN ACCESS

012010

Corrosion and Mechanical Properties of Austenic Steel Weld Joints

M A Kuznetsov, E A Zernin, V I Danilov, D E Kolmogorov and L N Zoubenko

 [View article](#)  [PDF](#)

OPEN ACCESS

012011

Influence of Frequency and Induction of Longitudinal Magnetic Field on The Electrode Metal Loss and its Spattering During MAG-Welding

D G Nosov and V V Peremitko

 [View article](#)  [PDF](#)

OPEN ACCESS

012012

Influence of Protective Gas Content on Quality of Welded Joint While Welding With Impulse Supply of Electrode Wire

N V Pavlov, A V Kryukov, E A Zernin and V V Gritsenko

 [View article](#)  [PDF](#)

OPEN ACCESS

012013

Development of New Materials and Technologies for Welding and Surfacing at Research and Production Center "Welding Processes and Technologies"

N A Kozyrev, R E Kryukov, G V Galevsky, D A Titov and V M Shurupov

 [View article](#)  [PDF](#)

OPEN ACCESS

012014

Effect of Heat Input Pulse on the Structure and Properties of Welded Joints of Steels Ferritic-Pearlitic Class, Operating Under Low-Frequency Temperature-Force Loading

Y N Saraev, V P Bezborodov and E A Putilova

 [View article](#)  [PDF](#)

OPEN ACCESS

012015

X-Ray Structural Study of 09Nn2Si Steel Welded Joints

N I Golikov, A A Platonov and Y N Saraev

 [View article](#)  [PDF](#)

OPEN ACCESS

012016

Some Aspects of Oxidation-Reduction Reactions under Carbon-Bearing Flux Welding

R E Kryukov, N A Kozyrev, G V Galevsky, Y V Bendre, V F Goryushkin and D V Valuev

 [View article](#)  [PDF](#)

OPEN ACCESS

012017

Titanium Carbide: Nanotechnology, Properties, Application

G V Galevsky, V V Rudneva, A K Garbuzova and D V Valuev

 [View article](#)  [PDF](#)

OPEN ACCESS

012018

Possibilities of Application of Carbon-Fluorine Containing Additions in Submerged-Arc Welding

N A Kozyrev, N E Kryukov, R E Kryukov, V F Igushev and I I Kovalskii

 [View article](#)  [PDF](#)

OPEN ACCESS

012019

A New the Chnology for Producing Carbide Alloys With Gradient Structure

T N Oskolkova

 [View article](#)  [PDF](#)

OPEN ACCESS

012020

Wear Resistant Coating on Tungsten Carbide Hard Alloy

T N Oskolkova

 [View article](#)  [PDF](#)

OPEN ACCESS

012021

Systems to Control Molten Metal Transfer in Arc Welding

A V Filonov, A V Kryukov and D E Gusarov

 [View article](#)  [PDF](#)

OPEN ACCESS

012022

Study of the Effect of Shrinkage Porosity on Strength Low Carbon Cast Steel

E OI'khovik

 [View article](#)  [PDF](#)

OPEN ACCESS

012023

Prospects for Establishment of Technological Complexes in Machine Building Industry on The Basis of Electromechatronic Propulsion Systems

Yu M Osipov, O Yu Osipov and V A Trifonov

[View article](#)[PDF](#)

Topic 2: Innovative technologies for producing and machining materials in mechanical engineering

OPEN ACCESS

012024

Patterns of folded structure formation in the maximum bending zone of [111] FCC single crystals

E A Alfyorova, D V Lychagin and A A Popov

[View article](#)[PDF](#)

OPEN ACCESS

012025

Preferred Orientation Evolution of Olivine Grains as an Indicator of Change in the Deformation Mechanism

D V Lychagin, P A Tishin, A S Kulkov, A I Chernyshov and E A Alfyorova

[View article](#)[PDF](#)

OPEN ACCESS

012026

Methods of noninvasive electrophysiological heart examination basing on solution of inverse problem of electrocardiography

M Grigoriev and L Babich

[View article](#)[PDF](#)

OPEN ACCESS

012027

Results of research on causes of the defects of laser marking articles

V V Markov, L I Lebedeva and N V Kanatnikov

[View article](#)[PDF](#)

OPEN ACCESS

012028

Thermocapillary model of formation of surface nanostructure in metals at electron beam treatment

V D Sarychev, S A Nevskii, S V Konovalov, I A Komissarova and E V Chermushkina

[View article](#)[PDF](#)

OPEN ACCESS

012029

Fatigue life of silumin irradiated by high intensity pulsed electron beam

S V Konovalov, K V Alsaraeva, V E Gromov and Yu F Ivanov

[View article](#)[PDF](#)

OPEN ACCESS

OPEN ACCESS

012030

Investigation of defect copper substructure disrupted in creep condition under the action of magnetic field

S V Konovalov, N G Yaropolova, D V Zaguyliaev, V E Gromov, Yu F Ivanov and I A Komissarova

 [View article](#) [PDF](#)**OPEN ACCESS**

012031

Influence of layer-by-layer laser sintering conditions on the quality of sintered surface layer of products

N A Saprykina, A A Saprykin, I F Borovikov and Y P Sharkeev

 [View article](#) [PDF](#)**OPEN ACCESS**

012032

Reduction of longitudinal ultrasonic oscillations in NaClO₃ crystals

E G Soboleva, A L Igisheva and T B Krit

 [View article](#) [PDF](#)**OPEN ACCESS**

012033

Estimation of Temperature Conductivity Coefficient Impact upon Fatigue Damage of Material

V Bibik and A Galeeva

 [View article](#) [PDF](#)**OPEN ACCESS**

012034

Simulation of thermal fields using different types of wide burnishing

N M Bobrovskij, P A Melnikov, S N Grigoriev and I N Bobrovskij

 [View article](#) [PDF](#)**OPEN ACCESS**

012035

Aspects of thermal field by wide burnishing

N M Bobrovskij, P A Melnikov, S N Grigoriev and I N Bobrovskij















 [View article](#) [PDF](#)**OPEN ACCESS**















012036

Influence of Cooling Rate in High-Temperature Area on Hardening of Deposited High-Cutting Chrome-Tungsten Metal

N N Malushin, D V Valuev, A V Valueva, A Serikbol and I F Borovikov

 [View article](#) [PDF](#)

-
- OPEN ACCESS** 012037
Oxidation Processes in Blowing Steel With Inert Gas into the Ladle
R A Gizatulin, D V Valuev, V A Trifonov, A V Valueva and A Serikbol
 [View article](#)  [PDF](#)
-
- OPEN ACCESS** 012038
Extraction of Chromium from Carbon Ferrochromium Residual Wastes
P P Lazarevskiy, R A Gizatulin, Yu E Romanenko, D V Valuev, A V Valueva and A Serikbol
 [View article](#)  [PDF](#)
-
- OPEN ACCESS** 012039
Optimizing Technological Parameters of the Reduction Processes in Treating Steels in a Ladle Furnace
R A Gizatulin, D V Valuev, A V Valueva, A Serikbol and I F Borovikov
 [View article](#)  [PDF](#)
-
- OPEN ACCESS** 012040
Ultrasonic Surface Treatment of Titanium Alloys. The Submicrocrystalline State
V A Klimenov, V A Vlasov, V Y Borozna and A A Klopotov
 [View article](#)  [PDF](#)
-
- OPEN ACCESS** 012041
Forecasting of operational indicators of grinding tools with the controlled form and orientation of abrasive grains
V A Korotkov and E M Minkin
 [View article](#)  [PDF](#)
-
- OPEN ACCESS** 012042
Entering the operative correction machining processes CNC
R Yu Nekrasov, A I Starikov and A A Lasukov
 [View article](#)  [PDF](#)
-
- OPEN ACCESS** 012043
Reliability Modelling while Designing and Improving Working Members of Agricultural Implements
V I Myalenko
 [View article](#)  [PDF](#)
-

- OPEN ACCESS** 012044
Manganese concentrate usage in steelmaking
O I Nokhrina and I D Rozhihina
 View article  PDF
-
- OPEN ACCESS** 012045
The use of coal in a solid phase reduction of iron oxide
O I Nokhrina, I D Rozhihina and I E Hodosov
 View article  PDF
-
- OPEN ACCESS** 012046
Processing of energy materials in electromagnetic field
A P Rodzevich, L V Kuzmina, E G Gazenaur and V I Krashenin
 View article  PDF
-
- OPEN ACCESS** 012047
Cutting capacity and strength of single grinding grains
V S Lyukshin, A V Barsuk and R R Fazleev
 View article  PDF
-
- OPEN ACCESS** 012048
On the Problem of Wear Resistant Coatings Separation From Tools and Machine Elements
S I Petrushin, R H Gubaidulina, S V Gruby and A V Likholat
 View article  PDF
-
- OPEN ACCESS** 012049
Influence of boric anhydride upon the physical and chemical properties of ferrosilicon slag
A M Yefimets, E P Tesleva and A V Solovyan
 View article  PDF
-
- OPEN ACCESS** 012050
Increasing the Operational Stability of Railway Core by Modifying
S N Fedoseev and Z M Mukhtar
 View article  PDF
-
- OPEN ACCESS** 012051
Research of influence of electric conditions of the combined electro-diamond

machining on quality of grinding of hard alloys

A S Yanyushkin, D V Lobanov and P V Arkhipov

 [View article](#)  [PDF](#)

OPEN ACCESS

012052

Finite Element Model of Trenchless Pipe Laying

P V Burkov, S P Burkova and A N Kravchenko

 [View article](#)  [PDF](#)

OPEN ACCESS

012053

Analysis of the influence of warming on the quality of soldered instruments

V V Konovodov, A V Valentov and I S Kukhar

 [View article](#)  [PDF](#)

OPEN ACCESS

012054

Influence of thick-walled cylinders length on the residual stresses generated during the single-cycle mandrelling

V F Skvortsov, A O Boznak, A B Kim and A Yu Arlyapov

 [View article](#)  [PDF](#)

OPEN ACCESS

012055

Stress and Strain State Analysis of Defective Pipeline Portion

P V Burkov, S P Burkova and S A Knaub

 [View article](#)  [PDF](#)

OPEN ACCESS

012056

Ultrasonic plastic deformation of steels

K Zaitsev, V Klimenov, M Loshchilova and C Polovnikov

 [View article](#)  [PDF](#)

OPEN ACCESS

012057

Research of surface activating influence on formation of adhesion between gas-thermal coating and steel substrate

Z Kovalevskaya, V Klimenov and K Zaitsev

 [View article](#)  [PDF](#)

OPEN ACCESS

012058

New design of cutters for coal mining machines

S Prokopenko, A Sushko and I Kurzina

 [View article](#)  [PDF](#)

OPEN ACCESS 012059

Estimation of cutting ability of cubic nitride boron wheels by surface microhardness criteria for pendulum grinding of high-speed steel plates

Ya I Soler and A I Shustov

 [View article](#)  [PDF](#)

OPEN ACCESS 012060

Estimating the cutting force when skiving with a radius cutter

A V Filippov and E O Filippova

 [View article](#)  [PDF](#)

OPEN ACCESS 012061

Experimental estimation of chip shrinkage under cup-tip cutting with straight and radius cutters

E O Filippova and A V Filippov

 [View article](#)  [PDF](#)

OPEN ACCESS 012062

Processing of brittle materials in the nanometer range of thickness of layers cut

M A Shavva, V V Lapshin and S V Grubyy

 [View article](#)  [PDF](#)

Topic 3: Automation and informatization, economy and management of a company

OPEN ACCESS 012063

Review of modern biometric user authentication and their development prospects

Z V Boriev, S S Sokolov and A P Nyrkov

 [View article](#)  [PDF](#)

OPEN ACCESS 012064

Using information technologies in dredging

D G Mamunts, S S Sokolov and A P Nyrkov

 [View article](#)  [PDF](#)

OPEN ACCESS 012065

Microsoft Business Solutions-Axapta as a basis for automated monitoring of high

technology products competitiveness

G O Tashchiyan, A V Sushko and S V Grichin

[View article](#) [PDF](#)**OPEN ACCESS**

012066

Forecasting risk of bankruptcy for machine-building plants

E Telipenko, A Zakharova and Svetlana Sopova

[View article](#) [PDF](#)**OPEN ACCESS**

012067

Software selection based on analysis and forecasting methods, practised in 1C

A N Vazhdaev, T Y Chernysheva and E I Lisacheva

[View article](#) [PDF](#)**OPEN ACCESS**

012068

Strategic Concept of Competition Model in Knowledge-Based Logistics in Machinebuilding

O V Medvedeva

[View article](#) [PDF](#)**OPEN ACCESS**

012069

Methods for control over learning individual trajectory

A A Mitsel and N V Cherniaeva

[View article](#) [PDF](#)**OPEN ACCESS**

012070

Formalization model of expert knowledge about a technical index level of engineering products

A A Zakharova and V V Ostanin













[View article](#) [PDF](#)**OPEN ACCESS**

012071

Increase of stability of functioning of a production system of machine-building enterprise

A A Rudenko, D V Antipov and M O Iskoskov

[View article](#) [PDF](#)**Topic 4: Environmental protection, industrial labor safety**

-
- OPEN ACCESS** 012072
Analysis of air pollution from industrial plants by lichen indication on example of small town
K N Orlova, I R Pietkova and I F Borovikov
 [View article](#)  [PDF](#)
-
- OPEN ACCESS** 012073
Environmental management on the basis of Complex Regional Indicators Concept: case of the Murmansk region
A Kozlov, S Gutman, I Zaychenko, E Rytova and P Nijinskaya
 [View article](#)  [PDF](#)
-
- OPEN ACCESS** 012074
Engineering of centrifugal dust-collectors based on parallel comparing tests applying computer modelling
Y I Bulygin, D A Koronchik and A A Abuzyarov
 [View article](#)  [PDF](#)
-
- OPEN ACCESS** 012075
Methodology of research for qualitative composition of municipal solid waste to select an optimal method of recycling
M V Kravtsova and D A Volkov
 [View article](#)  [PDF](#)
-
- OPEN ACCESS** 012076
The Influence of Various Factors on the Methane Fermentation Process
M G Kurbanova, E A Egushova and OG Pozdnjakova
 [View article](#)  [PDF](#)
-
- OPEN ACCESS** 012077
Updating of sewage - purification facilities of electroplating enterprises with counterflow ion-exchange filters
V F Torosyan, E S Torosyan, P D Sorokin and A A Telitsyn
 [View article](#)  [PDF](#)
-
- OPEN ACCESS** 012078
The Study of Soil Protection in the System of the Cultivated Lands of Kemerovo Region
M A Yakovchenko, O B Konstantinova and A A Kosolapova

 [View article](#)  [PDF](#)

OPEN ACCESS 012079

Statistic analysis of acoustic noise in the industrial and living areas

I N Kirillov and V V Bulkin

 [View article](#)  [PDF](#)

OPEN ACCESS 012080

The problems of reducing the noise level on open sites of machine building plants and living areas

V V Bulkin and M V Kalinichenko

 [View article](#)  [PDF](#)

OPEN ACCESS 012081

Investigations of physicochemical properties of bottom-ash materials for use them as secondary raw materials

A G Mal'chik, S V Litovkin and P V Rodionov

 [View article](#)  [PDF](#)

OPEN ACCESS 012082

Carbon Nanotubes Influence the Enzyme Activity of Biogeochemical Cycles of Carbon, Nitrogen, Phosphorus and the Pathogenesis of Plants in Annual Agroecosystems

O B Vaishlya, N N Osipov and N V Guseva

 [View article](#)  [PDF](#)

Topic 5: Advanced technologies and equipment for agro-industrial complex (AIC) and mining

OPEN ACCESS 012083

Comparison of mathematical methods of geochemical data processing

A Marfin, D V Lychagin, A Shapovalov and E A Alfeyorova

 [View article](#)  [PDF](#)

OPEN ACCESS 012084

The distribution of stresses and strains in the mating elements disk tools working bodies of roadheaders



A A Khoreshok, L E Mametyev, A Yu Borisov and A V Vorobyev

 [View article](#)  [PDF](#)

OPEN ACCESS 012085

Development of math model of geokhod bladed working body interaction with geo-environment

V Yu Sadovets, V Yu Beglyakov and V V Aksenov



 [View article](#)  [PDF](#)

OPEN ACCESS

012086

The application of the analytic hierarchy process when choosing layout schemes for a geokhod pumping station

R V Chernukhin, A A Dronov and M Y Blashchuk



 [View article](#)  [PDF](#)

OPEN ACCESS

012087

Radial deformations of working cylinder of hydraulic Legs depending on their extension

G D Buyalich, K G Buyalich and V V Voyevodin

 [View article](#)  [PDF](#)

OPEN ACCESS

012088

Classification of geokhod units and systems based on product cost analysis and estimation for a prototype model production

V V Aksenov, A V Walter, A A Gordeyev and A V Kosovets

 [View article](#)  [PDF](#)

OPEN ACCESS

012089

Spectral analysis of granular material reaction to long-term weak dynamic effect

A A Kazantsev, V P Kosykh and A F Revuzhenko

 [View article](#)  [PDF](#)

OPEN ACCESS

012090

On the theory of plasticity, associated with a new integral characteristic of shearing stresses

A A Kazantsev, O A Mikenina and A F Revuzhenko

 [View article](#)  [PDF](#)

OPEN ACCESS

012091

Improving of the operation efficiency of the vehicle due to using of the neodymium magnets inside the vibration isolation devices

E G Gurova

 [View article](#)  [PDF](#)

OPEN ACCESS

012092

Research of the pre-launch powered lubrication device of major parts of the engine D-240

M Korchuganova, A Syrbakov, A Tkachev and T Zorina

 [View article](#) [PDF](#)

OPEN ACCESS

012093

Formation of the composition and properties of dumps on the open-pit mines of Kuzbass

Y V Lesin, S Y Luk'yanova and M A Tyuleneva

 [View article](#) [PDF](#)**JOURNAL LINKS**

[Journal home](#)

[Journal scope](#)

[Information for organizers](#)

[Information for authors](#)

[Contact us](#)

[Reprint services from Curran Associates](#)

[Journals](#)

[Books](#)

[IOP Conference Series](#)

[About IOPscience](#)

[Contact Us](#)

[Developing countries access](#)

[IOP Publishing open access policy](#)

[Accessibility](#)

[Copyright 2024 IOP Publishing](#)

[Terms and Conditions](#)

[Disclaimer](#)

[Privacy and Cookie Policy](#)

[Authors](#)

[Reviewers](#)

[Conference Organisers](#)

This site uses cookies. By continuing to use this site you agree to our use of cookies.

IOP