

Influence of the Geometry of Beveled Edges on the Stress-Strain State of Hydraulic Cylinders

This content has been downloaded from IOPscience. Please scroll down to see the full text.

2016 IOP Conf. Ser.: Mater. Sci. Eng. 127 012012

(<http://iopscience.iop.org/1757-899X/127/1/012012>)

View [the table of contents for this issue](#), or go to the [journal homepage](#) for more

Download details:

IP Address: 193.233.152.253

This content was downloaded on 10/05/2016 at 05:29

Please note that [terms and conditions apply](#).

Influence of the Geometry of Beveled Edges on the Stress-Strain State of Hydraulic Cylinders

G B Buyalich^{1,2}, A V Anuchin¹, K P Serikov¹

¹ Yugra Technological Institute branch of Tomsk polytechnic University, Russia, Kemerovo region, Yurga, Leningradskaya str. 26

² T.F. Gorbachev Kuzbass State Technical University, Russia, Kemerovo, Vesenniyaya str.28

E-mail: gdb@kuzstu.ru, avanuchin@tpu.ru

Abstract. The studies were carried out to determine the influence of forms obtained when preparing edges for welding a cylinder for hydraulic legs; the maximum stresses were defined at the location of weld roots, depending on variable parameters. The stress-strain states were calculated using finite element method.

1. Introduction

Underground mining methods are mainly employed to extract expensive coking coal. Coal is extracted mechanically from long wall faces. Workloads when using longwall mining techniques have been steadily increasing over the last 15 years, while the number of long walls is decreasing. During a given period, the number of longwall faces has been reducing from 170 to 75 [1]. The reliability and durability of longwall mining equipment is of vital importance in this context.

The main basic equipment for longwall mining consists of hydraulically powered supports having a large number of sections. Hydraulically powered supports provide mechanization of roof control and movement of equipment. The main element used to support the roof is a hydraulic leg (Figure 1). The malfunction of this element causes the halt of the whole process of mining, and the malfunction of hydraulic legs in numbers leads to emergency shutdown situation in the face. Research works towards improving the performance of hydraulic legs are relevant.

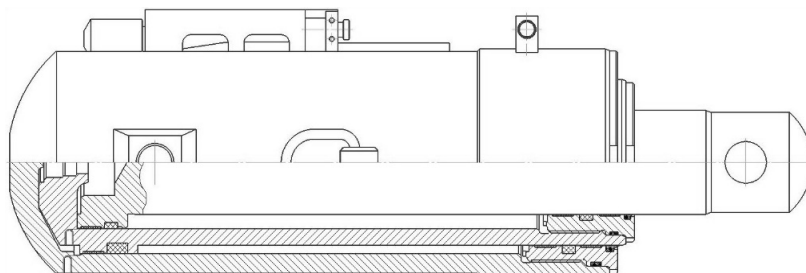

Figure 1. A Hydraulic Leg of Powered Roof Support.



A hydraulic leg consists of a hydraulic cylinder, piston rods of the first and the second stages. Its sealing capacity depends on the design of its main elements [2], forming radial clearances in the working cylinders, and the operation of cup seals in these clearances [3]. The hydraulic cylinder and the first-stage piston rod are welded components consisting of a cylinder and a bottom. Service capabilities of these components depend on the soundness and quality of welds. Metal welding processes are being studied quite extensively [4-8], while the influence of joint configurations prepared for welding is not presented enough in researches at the moment.

2. Influence of the geometry of beveled edges on the stress-strain state

Analyzing the designs of two-stage hydraulic legs with an inside diameter of 220 mm manufactured by various companies, we find a variety of welding edge joints (Figure 2). They can be divided into four types: square groove edge joints (Variant 1); U-groove edge joints (Variant 2); special V-groove edge joints with an opening angle of 36° (Variant 3); special U-groove edge joints with an opening angle of 40° (Variant 4).

Using a square groove edge joint is characterized by a smaller amount of weld metal required to fill in the joint, and this, in turn, reduces heat-affected zones. In case of the square groove edge joints, the hydraulic cylinder bottom has a functional step, which is necessary to build a precise gap between parts prepared for welding. The main limitation for using this type of weld joints is lack of fusion at the location of the step, which forms the stress concentrator and increases the risk of occurrence of cold cracks, causing the rapid development of cracks under alternating loads with further structural damage to hydraulic leg cylinders.

The design of U-groove edge joints makes possible to ensure penetration in the zone of the functional step, but due to the improper joint dimensions to allow enough access of the electrode into the joint, there is a risk of lack of fusion in the weld root, that can also cause the appearance of cracks. It can be assumed that the third and the fourth variants have been derived after considering the limitations of the first and the second variants. These variants allow more access of the electrode into the joint and ensure appropriate fusion in the region of the functional step, avoiding the appearance of stress concentrating point. The limitation for using the latter groove edge joints is large amounts of weld metal needed and additional manufacturing costs.

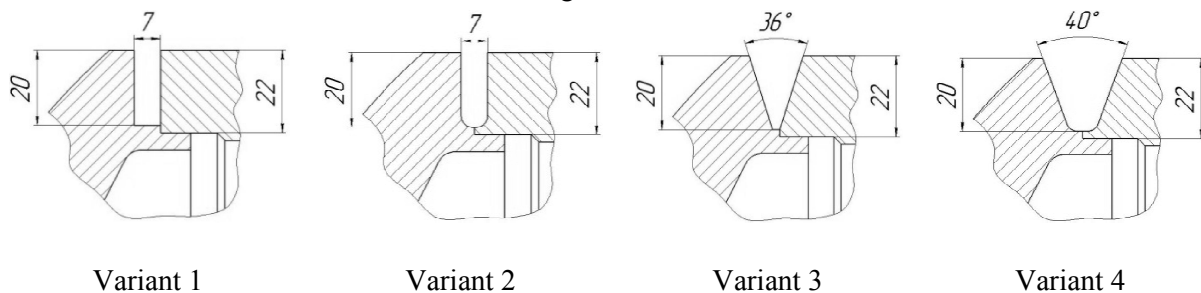

Figure 2. Configuration of edges beveled for welding bottoms and cylinders:

- a) square groove edge joint;
- b) U-groove edge joint;
- c) V-groove edge joint with an opening angle of 36° ;
- d) special U-groove edge joint with an opening angle of 40° .

We analyzed the influence of prepared for welding edge joints on the stress-strain state using the SolidWorks Simulation package. The cylinder designs of hydraulic legs M138 were tested. The forms of bottom and cylinder cutting edges are given in Figure 3. The inside diameter D is 220 mm and the overall length L is 750 mm and remain unchanged. To construct a model we used a stop piece, which is a part of tooling used during the real-life tests of hydraulic legs for their strength.

A three-dimensional model was constructed by turning contours of the working cylinder, the bottom and the weld joint around the longitudinal axis of symmetry to a central angle $\alpha = 90^\circ$ (Figure3). According to the researches performed earlier [9], the model with a central angle α of 90° is the most relevant in terms of the smallest error and the maximum computing performance. The designed weld had regions of penetration between the welded workpieces. Steel 30KhGSA was used for making the cylinder and the bottom, and wire SV-08G2S was used for welding. Table 1 shows the main properties of the materials used.

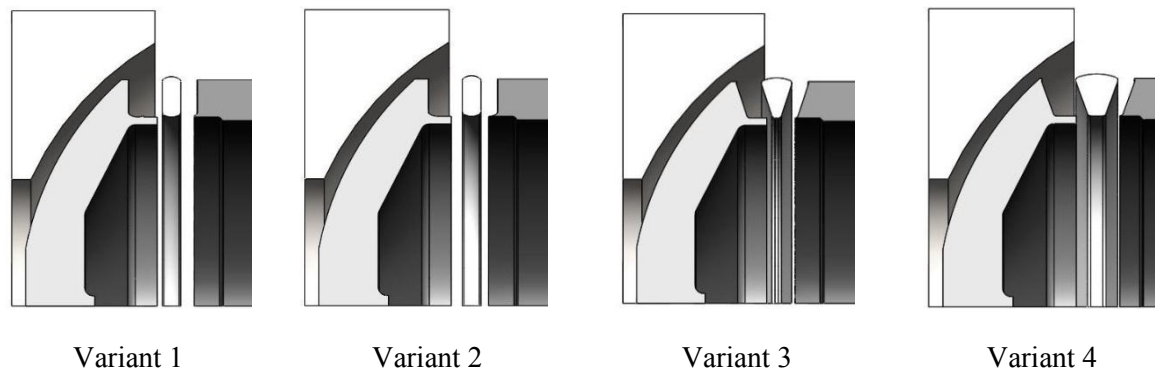

Figure 3. Solid model of the cylinder with a technological stop piece.

Table 1. Properties of Material used for Model

Material	Components	Module of Elasticity E, GPa	Ultimate Tensile Strength σ_t , MPa	Poisson's Ration μ
Steel 30KhGSA	Bottom, cylinder	205	736	0.3
Wire Sv-08G2S	Welding joint	220	415	0.275

The boundary condition “Symmetry” was applied to the surfaces of the simulated model to compensate for the effects of omitted parts in the structure. In setting the conditions of interaction between parts used in the assembly, the No Penetration contact condition with the Surface-to-Surface Contact option was applied. The weld joint between the tube and the bottom of the cylinder was simulated separately, and allowed for penetration zones of the parts welded. For the first variant, the functional step penetration was not taken into account. For other variants, the value of penetration is determined according to formula 1:

$$h_p = C - 0.5b \quad (1)$$

Where C is the height of the functional step, b is the gap between the parts to be welded. According to our calculations, the value of penetration was 2 mm.

For adding loads on the cylinder model, the pressure load equal to the test pressure of working fluid was applied to the inside surface of the cylinder and the bottom. According to the program and procedure of testing this hydraulic leg for strength, the test pressure $P_{\text{test}} = 60$ MPa.

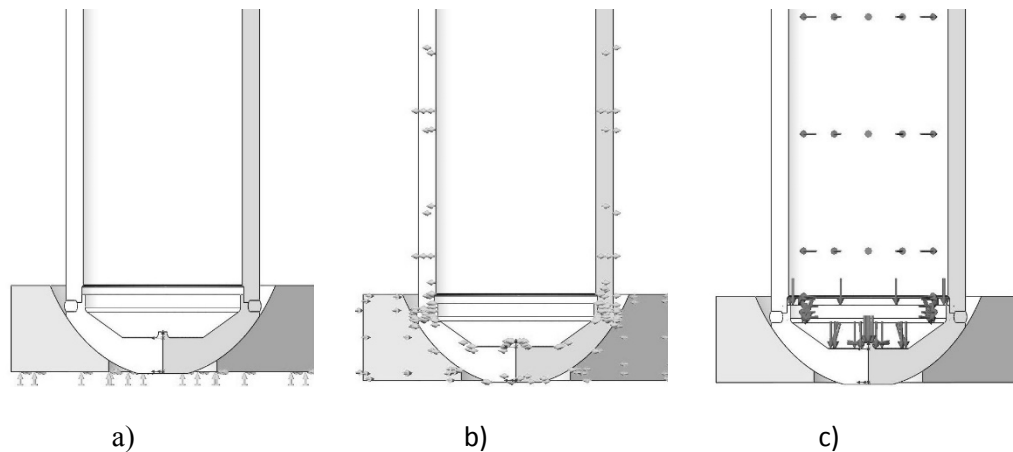

Figure 4. Boundary conditions in the cylinder model simulation:
a) Fixed Geometry; b) Symmetry; c) Load.

The type of mesh used is ‘Solid Mesh’ with the ‘Curvature-based Mesh’ option. Previously conducted numerical experiments to determine the von Mises stresses [9-10] showed that the optimal element sizes in applying Finite Element Analysis are as follows: 4 mm for cylinders and cylinder bottoms, and 0.4 mm relating to weld. A decrease in the element size increases the inaccuracy of research and the time for calculation. To reduce the calculation time we used the function "Mesh Control Property Manager" to change a mesh density at the regions where the components are in contact.

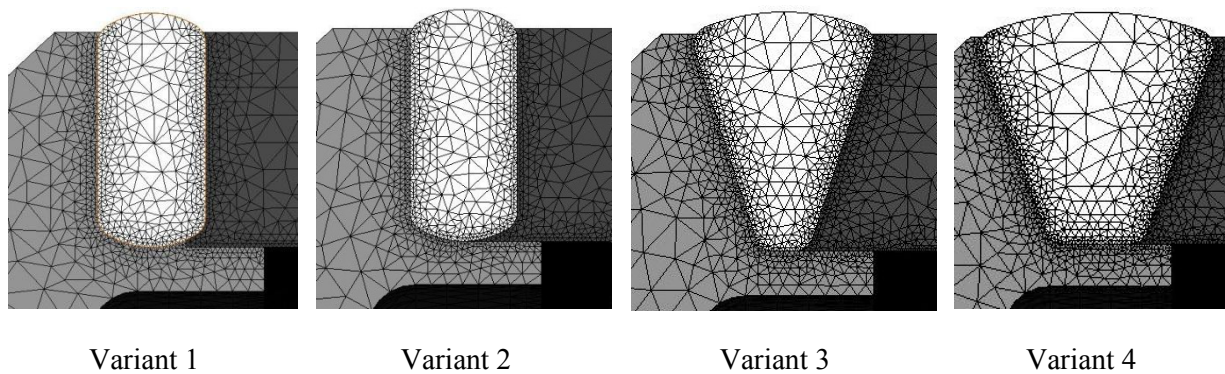

Figure 5. Mesh density with different element sizes at the region of weldment.

The results of numerical experiments performed to determine the von Mises stresses are given in Figure 6. As it can be seen from the figures, the maximum stresses occur at the root of a weld joint over the boundary of penetration of the connected cylinder components. The value of stress changes depending on a type of beveled edge joints. Thus, the value of stress is 634 MPa with the square groove edge joint; the value of stress is 558 MPa with the U-groove edge joint; the value of stress is 675 MPa with the special V-groove edge joint and an opening angle of 36°; the value of stress is 405 MPa with the special U-groove edge joint and an opening angle of 40°. The first three variants have zones where the stresses exceed the ultimate tensile strength of the weld material by 52%, 34% and 62% respectively. In the case of the fourth variant, the value of stress also approaches to the ultimate tensile strength of the weld material, but the the region of stress is small in comparison with the region of penetration.

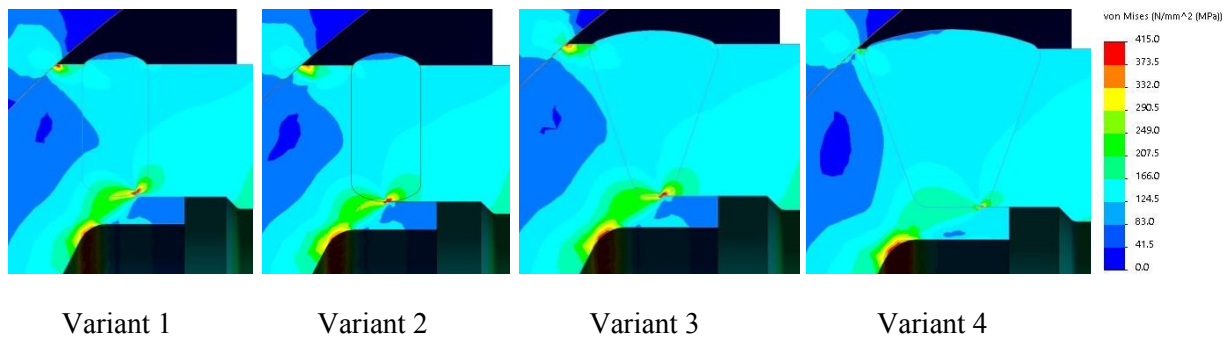

Figure 6. Von Mises stresses defined for different variants of a weld.

3. Additional research

The occurrence of such regions is caused by lack of fusion at the location of the functional step. These regions can be called as stress concentrators that are formed due to the distinct features of different joint edges beveled for welding.

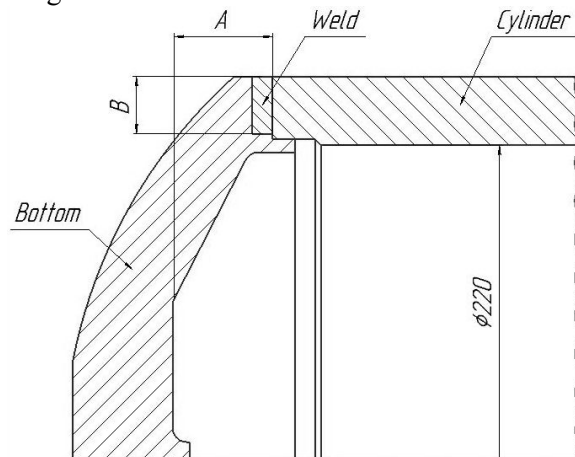

Figure 7. Variable parameters A and B.

In order to determine the change in maximum stresses at the region of the weld root, we carried out additional experiments with introducing variable parameters (Figure 7): A is the distance between the inside surface of the bottom and the cylinder; B is the height of weld. The value of parameter A changes from 31.5 mm to 71.5 mm with an increment of 10 mm. The value of parameter B varies within a range of 20 mm to 12 mm with an increment of 2 mm. For researches in the context of the parameter A, a model was built by means of changing the bottom and the cylinder when dimensions and forms of beveled edges are constant. The modeled weld having penetration regions remained unchanged for all four variants, i.e. the parameter B was constant and equal to 20 mm. In studies relative to the parameter B, the parameter A remained constant and was 31.5 mm.

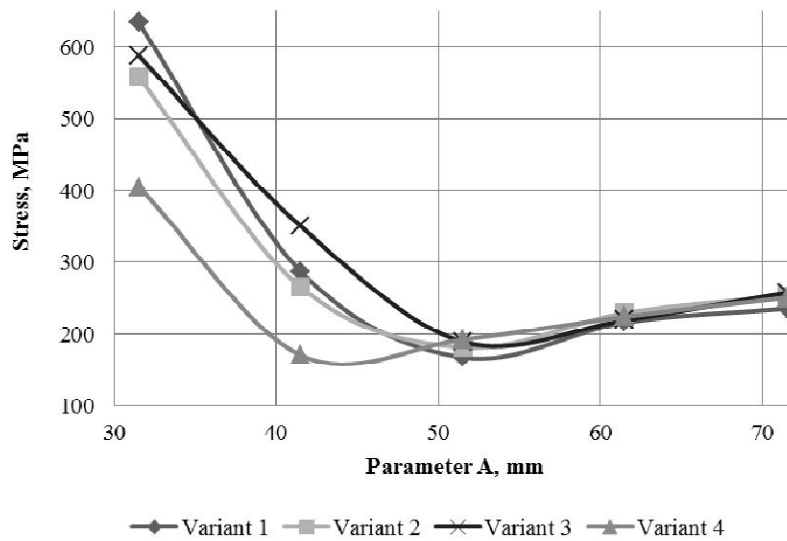

Figure 8. Changing of stresses in the weld root relative to parameter A when B = 20 mm, for four variants.

Results of new studies are presented in Figure 9. From these dependencies relating to changes of the parameter A it is seen that when the weld shifts away from the cylinder bottom, a sharp reduction in stresses occurs in the root zone of the weld, for all four models. The minimum stress in a given zone is obtained with the square groove edges (Figure 2, a) used to joint the bottom and the cylinder within a parameter range of 50 mm to 55 mm. A further increase in the parameter results in a growth of stresses. The parameter A can not be increased indefinitely, as the overall size of the bottom increases greatly, and this structure without changing the first - stage piston rod is impossible to apply.

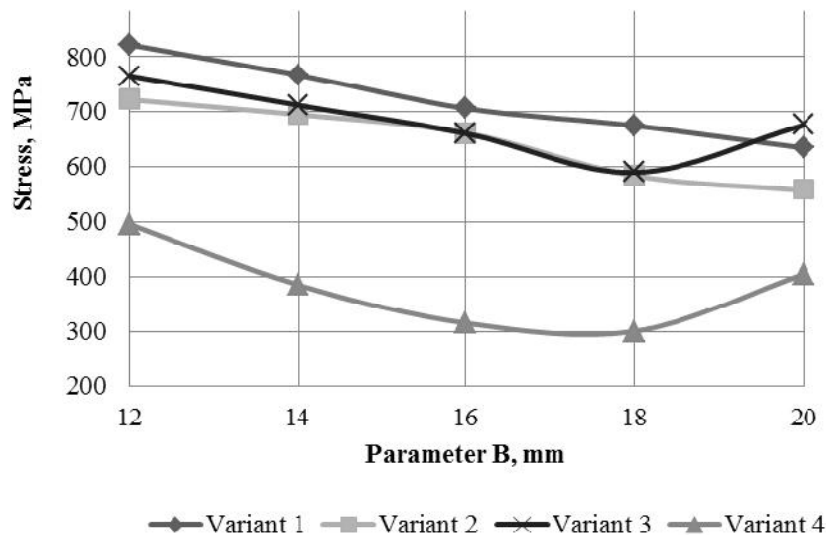

Figure 9. Changing of stresses in the weld root relative to parameter B when A = 31,5 mm, for four variants.

As it can be seen from the graph, changing a depth of the weld (parameter B) results in a reduction of stress in the region of the weld root only for the third and the fourth variants (models with the

special V-groove and U-groove edge joints and opening angles of 36 ° and 40 ° respectively (Figure 2, c, d)). The values of stress for these variants are 300 MPa and 590 MPa when the parameter B = 18 mm. Relative to other variants of beveling edges, stresses increase linearly and the depth cannot be reduced. For the fourth variant, a decrease in depth of the weld causes the reduction of stresses that positively affects the entire structure as a whole.

4. Conclusion

The analysis results have proved that all variants of cylinders under study have stress concentrations in the region of the root of welds. These stresses exceed an ultimate tensile strength of materials used for welding by 34-62%. The value of stress directly depends on the geometry of beveled edges and the value of penetration of the functional step. The larger the dimension of opening, the deeper the fusion extends into the functional step. Even full penetration does not ensure optimal stresses in the zone of the weld root, what is obvious when analyzing the fourth variant. The stress can be reduced by changing the design of the bottom with decreasing the depth of weld.

References

- [1] Tarazanov I 2014 Results of the coal industry of Russia in January-September 2014. *Ugol (Coal)* **No.12** pp 57-71
- [2] Buyalich G D Buyalich K G Voyevodin V V 2015 Radial deformations of working cylinder of hydraulic legs depending on their extension. *IOP Conference Series: Materials Science and Engineering* **Vol. 91** № 1
- [3] Buyalich G D Buyalich K G 2014 Modeling of Hydraulic Power Cylinder Seal Assembly Operation, *Mining 2014 : Taishan Academic Forum – Project on Mine Disaster Prevention and Control: Chinese Coal in the Century: Mining, Green and Safety, China, Qingdao, 17–20 October 2014*. Amsterdam, Paris, Beijing. Atlantis Press, pp. 167–170
- [4] Chinakhov D A 2011 Study of Thermal Cycle and Cooling Rate of Steel 30XFCA Single-Pass Weld Joints *J. Applied Mechanics and Materials* **Vol. 52-54** pp 442–447
- [5] Chinakhov D A 2013 Simulation of Active Shielding Gas Impact on Heat Distribution in the Weld Zone, *J. Applied Mechanics and Materials* **Vol.762** pp 717-721
- [6] Malushin N N Valuev D V Valueva A V Serikbol A 2011 Testing of metallurgical equipment on contact strength and wear resistance *J. Applied Mechanics and Materials* **Vol.682** pp 53-57
- [7] Malushin N N Valuev D V 2013 Measuring stress condition in hard faced work rolls for cold rolling *J. Applied Mechanics and Materials* **Vol. 379** pp 71-76
- [8] Malushin N N Osetkovsky V L Valuev D V Valueva A V Serikbol A 2014 Selection criteria parameter thermal cycle during surfacing heat resistance high hardness parts of metallurgical equipment *J. Applied Mechanics and Materials* **Vol. 682** pp 69-74
- [9] Buyalich G D Anuchin A V Dronov A A 2015 The Numerical Analysis of Accuracy of Hydraulic Leg Cylinder in Modeling Using Solid Works Simulation *J. Applied Mechanics and Materials* **Vol. 770** pp 456-460
- [10] Buyalich G D Buyalich K G Voyevodin V V 2015 Radial deformations of working cylinder of hydraulic legs depending on their extension *IOP Conference Series: Materials Science and Engineering* **Vol. 91**